

Worksman Adaptable Industrial Tricycle Owner's Manual

Worksman Cycles Co. - Ozone Park, NY & Conway, SC - (718) 322-2000

Web: www.worksman.com

Email: cycles@worksman.com

Parts list AD1221

Models ADP, ADB, ADC, ADBB, -CB, -3CB, -NDB



Worksman Adaptable Tricycles - The World's Original Industrial Tricycle

Congratulations! You have purchased a true industrial tricycle – the Worksman Adaptable Industrial Tricycle. The Adaptable is considered the father of the Worksman Business Cycle System, which is undoubtedly the finest line of industrial cycles. These durable tricycles are used around the world by leading companies and organizations to move personnel and supplies efficiently and safely in an environmentally friendly manner.

Before assembling and riding, make certain to read this manual and any other literature provided thoroughly. Always follow the rules of safe riding. Always keep your Adaptable tricycle in tip-top shape by replacing worn parts as needed with genuine Worksman Cycles parts. (Do not use generic bicycle parts.) With simple maintenance, your Worksman Adaptable Tricycle will perform reliably day after day, year after year.

- *This manual is intended as an assembly and maintenance guideline for a professional and qualified bicycle mechanic. Failure to have this cycle professionally assembled could result in injury or death.*

Worksman Adaptable Parts List (For all freewheel, coaster brake and three-speed coaster brake Adaptable Tricycles.)

Note: As of 2013, Worksman uses ED (electrodeposition) black electro-coated components as standard equipment, including black handlebars, crank parts, and stems to help prevent rust and increase parts lifespan.

Frame, Fork and Related Parts (Forks include Bottom Cone # 51.)

<u>Part #</u>	<u>Description</u>	<u>Part #</u>	<u>Description</u>
72ACB	Adaptable Frame (Specify color)	60HD	Fork w/ Drum Brake Tab - Black
60HD-SP	Fork w/ Drum Brake Tab - Special color	50A	Headset Complete (48,49,52,53,54)
48	Headset Cups (pair)	49	Headset Bearings (pair)
51	Bottom Cone (Pressed on fork)	52	Top Adjusting Cone (threaded)
53	Key Washer	54	Fork Top Lock nut
55B	Handgrips (pair)	55F	Handlebar - Junior High Rise (Chrome)
55F-BLK	Handlebar - Junior High Rise (Black)	55A-BLK	Stem (Black)

Front Drum Brake Parts (Old style hub had loose bearings. New style hub has pressed bearings.)

<u>Part #</u>	<u>Description</u>	<u>Part #</u>	<u>Description</u>
<u>OLD STYLE</u>			
L918	Bearing Cup (pair)	L709	Front Axle Set for Drum Brake
F817M	Wheel Bearings - Loose 50 balls	L725-1	Drum Brake Plate Kit (Old or new style)
<u>NEW STYLE</u>			
L500-F	Hub - NEW STYLE w/ pressed bearing	L509	Axle - NEW STYLE for pressed bearing
L517	Pressed Bearing - NEW STYLE	L725-1	Drum Brake Plate Kit (Old or new style)
F719	Drum Brake Cable w/ F769 and F770	F816	Axle Washer
F769	Anchor Bolt Assembly for F719 Cable	F770	Adjusting Barrel for F719 Cable
L752R	Brake Lever (Right) w/ Parking Lock	160B	Fork Retention Clip (each)
L752L	Brake Lever (Left) w/ Parking Lock	L815	Outside Axle Nut (each)
F818	Brake Arm Strap (Small / Silver)	60STR	Brake Arm Strap (Bigger / Rubber)

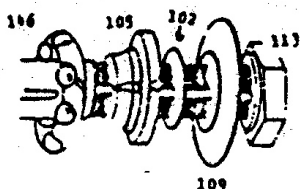

109

Free Side Rear Wheel - Exploded View

Rear Axle and Related Parts

<u>Part #</u>	<u>Description</u>	<u>Part #</u>	<u>Description</u>
101	Hub for Free Wheel w/ Cups	102	Key Lock Washer
103	Cups for 101 Hub	105	Adjusting Cone (threaded)
106	Stationary Cone (presses onto axle)	109	Dust Washer
113	Locknut - Left Hand Thread - Free Wheel Side	146	Wheel Bearings (pair)
130	Axle Parts Set (102,105,109,113,146,59A,93D)	3980	Drive Wheel Hub
58A	Rear Axle (31 1/2") w/ 106	58	Rear Axle (34" - Pre 1965)
58AK	58A Axle w/ (2) 91's, 130 kit, 69 sprocket	59A	Locknut - Drive Side
69	Fixed Drive Sprocket	4129	Freewheel Sprocket (22 tooth)
63AD	Bushing for 4129 (freewheel models)	63B	Set screw for 69 and 4129
62C	Keyway for Rear Sprocket	91	Pillow Block Bearings (each)
91A	Bolt, Nut, Washer for 91 Bearing	93	Spacer Washer for Left Side Wheel
93A	Washer - Drive Side Spacer	301	1 Speed Coaster Brake Hub
404N	3 Speed Coaster Brake Hub	F818	Coaster Brake Arm Strap
302	Coaster Brake Conversion Kit (Freewheel>CB)	SS12N-1	3 Speed Cable and Trigger for 404N
405	3 Speed Conversion Kit (Freewheel>3CB)	SS721	Coaster Brake Internal Part Kit (for 301)

Crank Parts (Pedal Section) and Chains

<u>Part #</u>	<u>Description</u>	<u>Part #</u>	<u>Description</u>
1265	Crank Parts (1266/1268/1269/1271/1272/1273/1274)	1265BMXS	Deluxe Sealed Crank Set (Upgrade)
1266	Crank Bearings (pair)	1268	Cups for Crank Housing (pair)
1267D	Complete Crank Set (36T blk sprocket, crank, 1265)	1269	Stationary Washer (inside)
1267F	Complete Crank Set (32T blk sprocket, crank, 1265)	1267H	Complete Crank Set (28T blk sprkt, crank, 1265)
1271	Key Washer (outside)	1272	Adjusting Cone (threaded, outside)
1273	Stationary Cone (inside)	1274	Crank Locknut
1275	Crank (one piece, forged, 6 1/2", plated)	1275-EDB	Crank (one piece, forged, 6 1/2", black)
1380D	Sprocket 36 Tooth (3/16", Chrome)	1380D-EDB	Sprocket 36 Tooth (3/16", Black)
1380F	Sprocket 32 Tooth (3/16", Chrome)	1380F-EDB	Sprocket 32 Tooth (3/16", Black)
1380H	Sprocket 28 Tooth (3/16", Chrome)	1380H-EDB	Sprocket 28 Tooth (3/16", Black)
4910A	Chainguard (Chrome plated - optional)	4910P-BLK	Chainguard (Black plastic - standard)
7217	Pedal Set	7217-41557	Pedal Set - Alloy Platform (Optional)
7217-EXT	Pedal Extenders (mounts pedals further apart)	4914A	Chain Connecting Link (1/2"x3/16")
4914B	Chain (freewheel models)	4914C	Chain (long for 32T and coaster brake)
4914EE	Chain (short for coaster brake)	4914F	Chain (long for 36T and coaster brake)
4915	Chain Adjusters (for coaster brake)		

Note - The Adaptable comes standard with a 36 tooth front sprocket and 1265 crank part set. Smaller sprockets in the front will reduce the gear ratio, making it easier to start pedaling. The 1265BMXS is a sealed, heavier duty upgrade for crank parts.

Seats, Seatpost, Baskets, Cabinets, and Fenders (Black resin polycarbonate fenders became standard starting in 2013.)

<u>Part #</u>	<u>Description</u>	<u>Part #</u>	<u>Description</u>
6910V	Saddle (wide w/o springs - standard)	6911V	Saddle (wide w/ springs - optional)
4908C	Seatpost (12" x 7/8")	7913A	Seatpost Clamp (seatpost to seat)
4909	Bolt, Nut, Washer for 4911C	4911C	Seatpost Clamp (seatpost to frame)
3927	Rear Cabinet (22"x15"x16")	5927BLK-C	Rear Wire Basket (21"x15"x9")
7227-P	Rear Flat Steel Basket (24"x17"x12")	133GB	Removable Front Basket (14.5"x9.5"x9")
7228	Front Wire Basket (21"x15"x9")	139	Front Wire Basket (18"x13"x6")
82	Front Fender (Chrome)	82-C	Front Fender w/ all parts attached (Chr)
82P-BLK	Front Fender (Black Polycarbonate)	82P-BLK-C	Front fender w/ all parts attached (Blk)
83A	Front Fender U-Brace		
82K	Front Fender Hardware Kit (95, 4907, 4907A)	95	Front "L" Bracket (fender to fork)
4907	Bolts, Nut, Washer (U-brace to fender)	4907A	Bolt, Nut, Washer ("L" bracket to fork)
4902	Rear Fender (Fits 24" & 26" - Chrome)	AD26*	Complete Rear Fender Kit (26" Chrome)
4902P-BLK	Rear Fender (Fits 24" & 26" - Black)	AD24*	Complete Rear Fender Kit (24" Chrome)
84	Rear Fender Brace Set (26", one side)	AD26P-BLK*	Complete Rear Fender Kit (26" Black)
84A	Rear Fender Brace Set (24", one side)	AD24P-BLK*	Complete Rear Fender Kit (24" Black)
4902K	Rear Fender Hardware (6-4905, 6-4906)	4905	Bolt, Nut, Washer (rear fender to brace)
4906	Bolt, Nut, Washer (rear fender brace to 92)	92	Rear Fender Brace Bracket (on frame)

* Complete rear fender kits include 2 rear fenders, 6 braces, and all nuts and bolts. Bracket # 92 is not included.

Wheels and Tires

<u>Part #</u>	<u>Description</u>	<u>Part #</u>	<u>Description</u>
77A	26" Front Wheel w/ Drum Brake	77	26" Front Drum Brake Wheel w/ Air Tire
77S	26" Front Wheel w/ Drum Brake w/ Solid Tire	77KVPR	26" Front Drm Whl w/ Kevlar Tire/PR Tube
77CAR	26" Alloy Front Wheel w/ Stainless Steel Spokes and Drum Brake (No tire or tube.)		
78A	24" Free Side Wheel	79A	24" Drive Wheel
78	24" Free Side Wheel w/ Air Tire	79	24" Drive Wheel w/ Air Tire
78SA	26" Free Side Wheel	79SA	26" Drive Wheel
1007	26" Free Side Wheel w/ Air Tire	1010	26" Drive Wheel w/ Air Tire
78S	26" Free Side Wheel w/ Solid Tire	79S	26" Drive Wheel w/ Solid Tire
1007CAR	26" Alloy Rear Free Side Wheel w/ Stainless Steel Spokes (No tire or tube.)		
79SA-ALUM	26" Alloy Rear Drive Side Wheel w/ Stainless Steel Spokes (No tire or tube.)		
9178SA	26" Free Side Welded Mag Wheel	9179SA	26" Drive Welded Mag Wheel
9178	26" Free Side Welded Mag Wheel w/ Air Tire	9179	26" Drive Welded Mag Wheel w/ Air Tire
9178S	26" Free Side Welded Mag Wheel w/ Solid Tire	9179S	26" Drive Welded Mag Wheel w/ Solid
1008A	20" Free Side Wheel	1009A	20" Drive Wheel
1008	20" Free Side Wheel w/ Air Tire	1009	20" Drive Wheel w/ Air Tire
1008S	20" Free Side Wheel w/ Solid Tire	1009S	20" Drive Wheel w/ Solid Tire
4922A	26"x2.125" WTC Sup-r-Tire	4922E	24"x2.125" WTC Sup-r-Tire
4922AKV	26"x2.125" WTC KEVLAR Sup-r-Tire	4922EKV	24"x2.125" WTC KEVLAR Sup-r-Tire
4922AWSW	26"x2.125" White Wall Sup-r-Tire	4922EWSW	24"x2.125" White Wall Sup-r-Tire
4939A	26" Solid Rubber Nev-R-Fail Tire	4938B	20" Solid Rubber Nev-R-Fail Tire
4923A	26"x2.125" Tube	4923E	24"x2.125" Tube
6023A	26"x2.125" Puncture Resistant Tube	6023B	24"x2.125" Puncture Resistant Tube
1017	26" Rim Strip	1017B	24" Rim Strip
1017T20	20" Tire Liner	1017T24	24" Tire Liner
1017T	26" Tire Liner		
101	Hub for Free Side Wheel	3980	Hub for Drive Side Wheel
1016	26" Rim Only (no spokes - rim only)	1016C	24" Rim Only (no spokes - rim only)
1016A	26" Alloy Rim Only (no spokes - rim only)	1015	20" Rim Only (no spokes - rim only)
1014A	Spoke (78S, 78SA, 1007) (11G, 10 9/16")	1014B	Spoke (77A, 77, 77S) (11G, 9 13/16")
1014C	Spoke (79, 79A) (11G, 9 9/16")		

CALL FOR PART #'s TO UPGRADE TO KEVLAR TIRES AND PUNCTURE RESISTANT TUBES!

Adaptable Tricycles come standard with WTC Clincher Wheels with 11 gauge spokes. They are very durable. Welded Style Wheels are available only for the rear wheels. Kevlar tires are belted air tires - ideal for preventing flats. Solid tires are solid rubber - no flats! Solid tires, mag rears, and alloy rim upgrades increase rear wheels to 26". Adaptables come with 26" front and 24" rear wheels.

Safety and Comfort Accessories

<u>Part #</u>	<u>Description</u>	<u>Part #</u>	<u>Description</u>
3979	Ding Dong Chime Bell	303	Squeeze Bulb Horn (chrome w/ rubber)
3973	Mega-Horn (battery operated)	201	Cable and Lock set (with keyed padlock)
4963	Rear View Mirror (Chrome, rectangular)	5030T	Reflector Kit
3978	Safety Flag on Pole	P19-A	Bicycle Helmet (Adult)
101710	Flashing Strobe Light (clear lens)	101714	Flashing Strobe Light (red lens)
7217-410204	Pedals with Velcro Foot Straps (pair)	3975	Generator Light Set
1006	Air Foot Pump	1000-01	Spoke Wrench
202	Mini-Frame Pump w/ Attachment Strap	2000-01	Chain Rivet Remover Tool
1265TW	Crank Cone Wrench	95021	Water Bottle w/ Cage, Attachment Strap
1001	Pedal Wrench	7917A	Backrest w/ Mounting Hardware
6001A	Patch Kit (5)	3976	Battery Operated Headlight
ENG-BKIT-26WTC	Electric Motor Kit 500W, 10ah Lithium Battery	7217GS12	"Glowspeck" Flashing Pedals

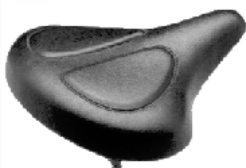

6910V Saddle



7228 Front Basket = 21"x15"x9"

Part #'s and Specifications subject to change without notice, as we are constantly seeking ways to improve our products.

ASSEMBLY INSTRUCTIONS FOR THE WORKSMAN ADAPTABLE™ INDUSTRIAL TRICYCLE:

Your Worksmen Adaptable™ Industrial Tricycle has been hand made by American Craftspeople at our Ozone Park, New York City factory. We take great pride in each and every Worksmen Business Cycle that we manufacture and appreciate your support. Please read this manual carefully prior to performing the simple finishing assembly and prior to riding. Keep these instructions as our parts list is contained within this document which you will need for future reference.

Carefully remove the tricycle from the carton. You will notice the tricycle is mostly pre-assembled at the factory. Some finishing assembly is required.

The front wheel and the fork assembly is pre-assembled at the factory.

TO ATTACH FRONT FORK/WHEEL ASSEMBLY TO THE FRAME:

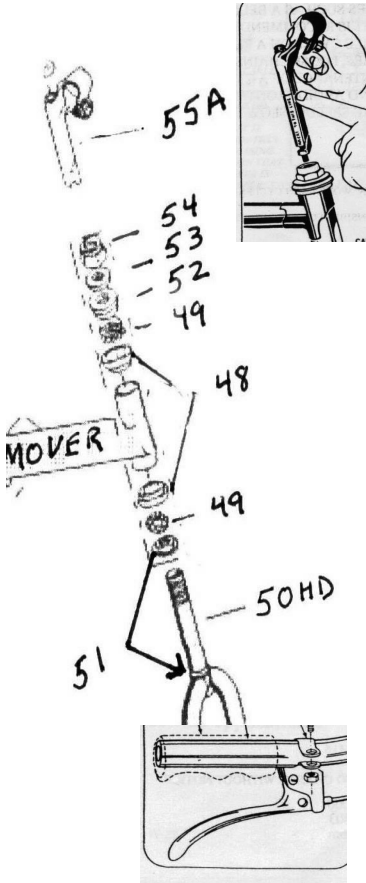

- 1) Grease cups (48) with Rustolene 200 lubricant or equal. Bearings (49) are pre-greased at the factory, but it is always a good idea to add lubrication prior to assembly.
- 2) Place one bearing (#49) onto the fork steering tube with the balls facing up.
- 3) Slide the threaded fork (#60HD) steering tube into the frame head.
- 4) Place the other bearing on the top of the fork tube with the balls facing down towards the cup (#48), which is already pressed onto the frame.
- 5) Install the top adjusting cone (#52) onto the treaded fork steering tube. Hand-tighten, making certain the bearings do not bind. After hand tightening, turn back ¼ turn.
- 6) Install the fork key washer (#53) on top of the adjusting cone with tip of washer in slot on steering tube.
- 7) Install head lock nut (#54) and securely tighten. Make sure that the fork rotates freely without being loose. Excess play or resistance must be adjusted. Failure to adjust properly can lead to improper steering response.
- 8) Install handlebar stem (55A) into the fork steering tube with the handlebar clamp facing forward. The stem must be inserted far enough to reach the minimum insertion line. Tighten the stem bolt slightly at this point. Loosen the handlebar clamp nut and slide the handlebar through the clamp centering the knurled center section of the handlebar into the clamp. Position the handlebar to the desired angle and tighten clamp securely. Recommended torque is 300 IN. LBS. Adjust the handlebar rotation so that it is perpendicular to the front wheel when it is perfectly straight. Tighten stem bolt securely. Recommended torque 240 IN. LBS. Be sure not to over tighten as damage to the parts may occur causing steering failure.
- 9) Attach brake hand lever to the handlebar (either left or right depending upon the rider's preference) Make sure brake cable is not tangled in anyway.

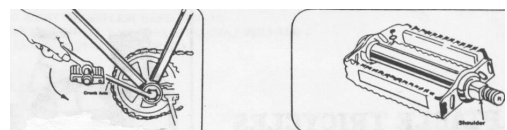

INSTALLING PEDALS:

Pedals are marked on the pedal shaft with either an "L" or "R" denoting left or right. The "R" pedal fits on the right (sprocket side) of the crank arm. Tighten clockwise. The "L" pedal fits on the left side of the crank arm. *Tighten counter-clockwise! The left pedal is left-hand thread!* Securely tighten. Recommended torque 275 IN. LBS.

CAUTION: Tightening in the wrong direction will damage the crank and pedal threads and is not covered under warranty.

SEAT ADJUSTMENTS:

Although the seat is already installed at the factory, adjust the height to your desired level by loosening the seat clamp nut at the top of the frame's seat tube. Re-tighten at desired height. Make sure a minimum of 3 1/2" of the post remains in the frame tube. Never adjust post above this level. Adjust angle of seat with nose raised slightly. Tighten seat clamp securely. (240 IN. LBS.)

REAR FENDERS:

Attach fender braces to fender, and fender braces to mounting bracket on frame using the provided nuts, bolts, and washers. Be sure to install the smaller fender brace in the middle. Bend braces slightly if tire is rubbing the brace.

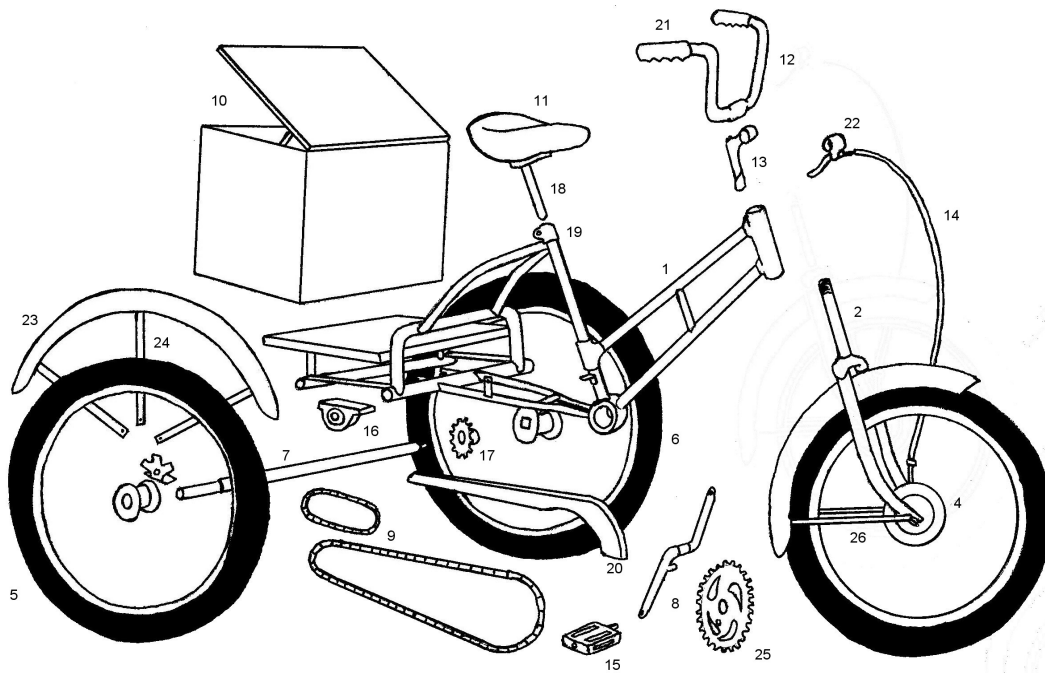

- | | |
|----|------------------------------------|
| 1 | 72ACB Frame |
| 2 | 60HD Fork |
| 3 | 77_ Front Wheels |
| 4 | L900 Drum Brake |
| 5 | 78_ Free Wheels |
| 6 | 79_ Drive Wheels |
| 7 | 58A Rear Axle |
| 8 | 1275 Crank |
| 9 | 4914_ Chains |
| 10 | 3927 Cabinet |
| 11 | 6910V/11V Seats |
| 12 | 55F Handlebar |
| 13 | 55A-BLK Stem |
| 14 | F719 Brake Cbl |
| 15 | 7217 Pedals |
| 16 | 91 Axle Bearing |
| 17 | 69 Fixed Gear OR
4129 Freewheel |
| 18 | 4908C Seatpost |
| 19 | 4911C Clamp |
| 20 | 4910_ Chainguard |
| 21 | 55B Handgrips |
| 22 | L752L/R Levers |
| 23 | 4902_ Fender |
| 24 | 84_ Fender Braces |
| 25 | 1380_ Sprockets |
| 26 | 83A Brace |

MAINTENANCE TIPS:

Always inspect your Worksman Cycle to ensure that all nuts, bolts, screws and hardware are tight and that no parts are worn or damaged. Do not attempt to straighten bent forks or frames.

Chain:

Lubricate chain once a month or as needed with light oil. Replace sprockets when teeth become worn, bent or broken. Keep chain adjusted so there is no more than 3/8" slack. Note that we make the chains tight at the factory, as we do know they will stretch during the break-in period.

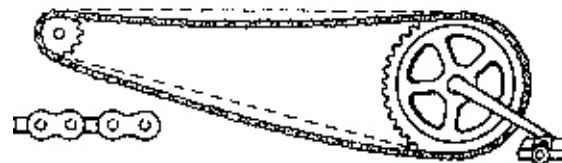

Lubricate crank parts every six months. Replace pedals when the surface is worn or if axle becomes "tight" or frozen.

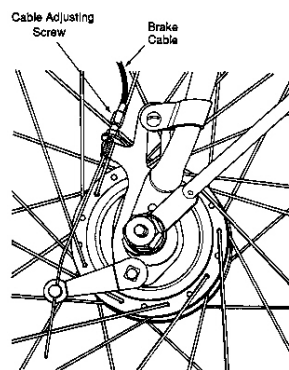

Drum Brake:

Your Worksman Adaptable Tricycle may be equipped with an automotive type front drum brake. This brake is ideal for slowing your vehicle smoothly and reliably. It is engaged by squeezing the hand lever on the handlebar. To use "Park" feature, when cycle is completely stopped, squeeze hand lever and push in parking plunger button on lever. To disengage, simply squeeze lever until parking plunger button releases.

Drum brakes are pre-adjusted at the factory. Readjust the cable tension as necessary using the adjusting barrel so that wheel spins freely and stops when brake is applied. Always replace worn brake cables (F719) and damaged hand levers. Internal parts kits are available for your drum brake (See parts list for part #'s.).

Coaster Brake (if applicable):

Foot activated coaster brakes are easy to use and reliable. To activate this internal brake, reverse the pedaling motion until the brake engages. To avoid skidding and maintain control, apply care when braking. This is especially true on wet surfaces. Apply brakes gently, gradually increasing pressure. Replace coaster brakes when they become worn. Check chain tension regularly. Coaster brake hubs may make a vibrating noise under braking until they are broken in. For three speed units, pause pedaling to help mesh gears. (Let the cycle coast.) This will make shifts smoother and will reduce wear and tear on the hub. Do not shift when pedals are not moving as damage could occur.

Tires:

Always check for worn or damaged tires. We recommend 40PSI as proper level of inflation. Replace tires that are worn or cut immediately. Replace or repair tubes that show leaks.

LIMITED WARRANTY:

THIS CYCLE IS WARRANTIED AGAINST FAULTY PARTS UNDER THE FOLLOWING CONDITIONS: THIS WARRANTY DOES NOT COVER ANY FAILURE DUE TO ACCIDENT, ABUSE, MISUSE, NEGLIGENCE OR AS THE RESULT OF NORMAL WEAR AND TEAR, OR IMPROPER ASSEMBLY. THE ENTIRE FRAME, INCLUDING ALL WELDED JOINTS, IS WARRANTED TO BE FREE FROM DEFECTS AND MATERIAL FOR ONE YEAR WHILE IN POSSESSION OF THE ORIGINAL PURCHASER. ALL OTHER PARTS ON THIS CYCLE, EXCEPT TIRES AND TUBES, ARE WARRANTIED FOR NINETY DAYS FROM THE DATE OF PURCHASE. REPAIR AND REPLACEMENT OF THESE PARTS IS TO BE ACCORDING THE WORKSMAN CYCLES PARTS AND SERVICE PROCEDURES AND MUST BE HANDLED DIRECTLY THROUGH THE SOURCE WHERE THE CYCLE WAS PURCHASED. IF UPON EXAMINATION OF THE PARTS IN QUESTION, THE WORKSMAN CYCLE DEALER DETERMINES THAT IT IS DEFECTIVE, EITHER REPAIR OR REPLACEMENT WILL BE MADE AT NO COST EXCEPT THE COST OF TRANSPORTATION AND LABOR CHARGES (IF ANY). UNAUTHORIZED REPAIRS OR REPLACEMENT AUTOMATICALLY VOIDS WARRANTY. PROPER MAINTENANCE IS REQUIRED FOR WARRANTY TO BE VALID. IN THE EVENT THAT IT WAS DETERMINED THAT THE WARRANTY CLAIM IS THE RESULT OF MISUSE, ABUSE, IMPROPER MAINTENANCE OR SIMPLY NOT DEFECTIVE OR BEYOND THE WARRANTY PERIOD, WORKSMAN CYCLES OR THE DEALER WILL ADVISE YOU AS TO THE COST OF REPAIR, REPLACEMENT OR LABOR PRIOR TO PERFORMING ANY WORK OR REPLACING ANY PARTS. IF YOU CHOOSE NOT TO HAVE THE DEALER OR WORKSMAN CYCLES PERFORM THE WORK, THE PARTS WILL BE RETURNED TO YOU AT YOUR EXPENSE OR DISCARDED IF NO REPLY IS RECEIVED WITHIN 2 WEEKS OF NOTIFICATION. THE SOLE RESPONSIBILITY OF THE MANUFACTURER TO THE TERMS OF THIS WARRANTY, IF ANY, SHALL BE THE REPAIR AND/OR REPLACEMENT OF THE PARTS AS INDICATED ABOVE. THE LIABILITY OF THE MANUFACTURER SHALL IN NO EVENT EXCEED THE ORIGINAL PURCHASE PRICE OF THE PRODUCT, AND THE MANUFACTURER SHALL NOT BE RESPONSIBLE FOR ANY CONSEQUENTIAL DAMAGES OF ANY NATURE, INCLUDING, BUT NOT BY WAY OF LIMITATION, DAMAGES FOR PERSONAL INJURY OR PROPERTY. THIS STATEMENT CONSTITUTES THE EXCLUSIVE EXPRESSION OF WARRANTIES BY THE MANUFACTURER AND IS IN LIEU OF ANY OR ALL OTHER WARRANTIES SUCH AS EXPRESSED WARRANTIES, IMPLIED WARRANTIES, INCLUDING BUT NOT LIMITED TO WARRANTIES OF MERCHANTABILITY, AND FITNESS OR PURPOSE, ARE LIMITED IN DURATION FOR ONE YEAR FROM THE DATE OF PURCHASE OF THE FRAME ONLY AND 90 DAYS FOR ALL OTHER PARTS, EXCEPT TIRES AND TUBES WHICH ARE NOT WARRANTED. WORKSMAN TRADING CORPORATION IS THE MANUFACTURER. MISUSE OF THE CYCLES INCLUDING OFF ROAD RIDING, INSTALLATION OF MOTORS OR POWER ASSISTS, ALTERATIONS, REPAIRS USING PARTS OTHER THAN GENUINE WORKSMAN CYCLE PARTS VOIDS WARRANTY. WORKSMAN TRADING CORPORATION IS NOT RESPONSIBLE FOR MAINTAINING RECORDS OF SERIAL NUMBERS. VOID WHERE PROHIBITED BY STATE LAW.

MAINTENANCE LOG

DATE MAINTAINED	MAINTENANCE PERFORMED
_____	_____
_____	_____
_____	_____
_____	_____
_____	_____
_____	_____
_____	_____

RULES FOR SAFE RIDING AND RESPONSIBLE OPERATION: Carefully read this manual before operating the cycle.

- It is the responsibility of the person who completes the assembly to properly install all parts included and to inspect the cycle prior to riding to insure proper operation.
- Operator is responsible for required maintenance to keep the cycle in good operation condition.
- Observe all traffic regulations in the operating environment. (Stop signs, etc.)
- Keep to the right and in a straight line. Ride in single file.
- Do not ride outdoors at night, and have appropriate signaling device as needed. (We recommend the 3973 Mega Horn.)
- Give pedestrians the Right of Way
- Always look around you to understand the riding environment and hazards.
- Do not carry passengers.
- Check brakes prior to riding.
- Slow down when approaching turns or intersections. Tricycles are meant for slow pace rides, not for racing.
- Use proper hand signals when turning or stopping.
- Recommended safety options include, but are not limited to, an approved helmet, audible warning device, front/rear lights and/or reflectors.
- Never ride the cycle if there are known repairs required.
- Do not exceed the recommended weight capacity of the cycle. (450 lbs., including the rider.)
- Place loads evenly on platform. Do not stack cargo too high and always secure cargo with appropriate tie down straps.
- Wipe surface of cycle clean and dry when exposed to corrosive substances or environment.
- Operate cycle at slow speeds, particularly in high traffic areas.
- Operators of cycles should be in good physical condition. Ride at your own risk.
- Wear proper riding attire. Check shoelaces and pant legs prior to riding so they do not become engaged in the chain and sprocket.
- Ride only on smooth, paved surfaces. Do not use off road.
- Do not operate a tricycle on steep grades. They are designed for relatively level, paved surfaces only.
- Always replace worn parts with genuine Worksmen Cycle Repair Parts.
- Always keep both hands on the handlebars. Tricycles have a tendency to pull slightly to one side.

Worksmen Cycles are made in the USA using foreign and domestic parts.

Visit us online at www.worksmen.com to see our full line of RECREATIONAL & INDUSTRIAL BIKES, TRIKES, ELECTRIC TRIKES!